

avant°pool

COOLING & HEATING UNIT (CHU)

INSTALLATION AND USER MANUAL



Please read this manual carefully before
installation, operation or maintenance.

Table of Content

Warning _____	3
Installation Distance _____	4
Installation of Drain Hose (optional) _____	4
Attaching Water Hoses to unit _____	5
Layout of water circulation between the unit and pool _____	5
Hanki pool – implementation steps _____	6
Kide Pool – implementation steps _____	9
Filling the Pool and letting air out of the unit _____	10
Operation _____	11
Operation Instruction of Controller _____	11
Power and Screen Lock _____	11
Modes (Cooling / Heating / Auto) _____	11
Temperature Setting _____	11
Time Setting _____	11
Power ON/OFF Timer Setting (“Active Mode”) _____	12
Ozonator Setting _____	12
Error messages on Display _____	13
General maintenance and quality of water _____	14
Maintenance tips _____	14
Warranty _____	15

Warning

- a) For repairs, please contact service. The repair process must be done in strict accordance with this manual. All maintenance operations by non-professional personnel are prohibited and will void warranty.
- b) Misoperation may result in injury to personnel or damage to equipment.
- c) Please make sure that the pool is filled up and air is removed from the unit piping before starting the unit. It is forbidden to start this equipment before a certain water level has been established. Otherwise, there is a risk of damage to this equipment and void of warranty.
- d) In winter or when the ambient temperature drops below 0°C, be sure to empty the water from the cooling unit if it is not in use. Otherwise, the unit will be damaged by freezing, in which case your warranty will be voided. The unit should not be used outdoors in ambient temperatures below -7°C.
- e) When there is a need to cut the power for repair, wait for 1 minute after power is off, before touching the circuit board, to avoid capacitor discharge resulting in electric shock.
- f) The cooling unit must be stored and transported vertically in its original packaging. If not, wait at least 24 hours before being powering the unit.
- g) The correct power supply, voltage, and frequency must be confirmed before installation.
- h) Improper installation may result in fire, electric shock, equipment falling, or water leakage.
- i) Make sure no water penetrates the electrical components.
- j) The unit may be damaged by severely overheating the product due to negligence, such as covering the cooling unit's ventilation grills with towels, clothing, or other objects, or operating the cooling unit too close to a wall or in a room/place with insufficient ventilation.
- k) Do not use salt or other minerals in the water.
- m) This equipment is not intended for use by children. Children must be supervised by an adult while using it to ensure their safety.
- n) Persons with a history of heart disease, low or high blood pressure, circulatory system problems, diabetes, or any condition requiring medical treatment should consult a physician or a doctor before using the pool.
- o) Persons using medication should consult a physician or a doctor before using the pool since some medication may induce drowsiness while other medication may affect heart rate, blood pressure and circulation.
- p) Pregnant women should consult a physician or a doctor before using the pool.

The unit should not be used in direct sunlight, due to the overheating of the device.

Installation Distance

The cooling unit should be installed in a well-ventilated area. It should be installed in the place greater than the following distances:

- Min. distance between unit front and wall = 1500mm (150 cm)
- Min. distance between unit back and wall = 300mm (30 cm)
- Min. distance between unit sides and wall = 200mm (20 cm)

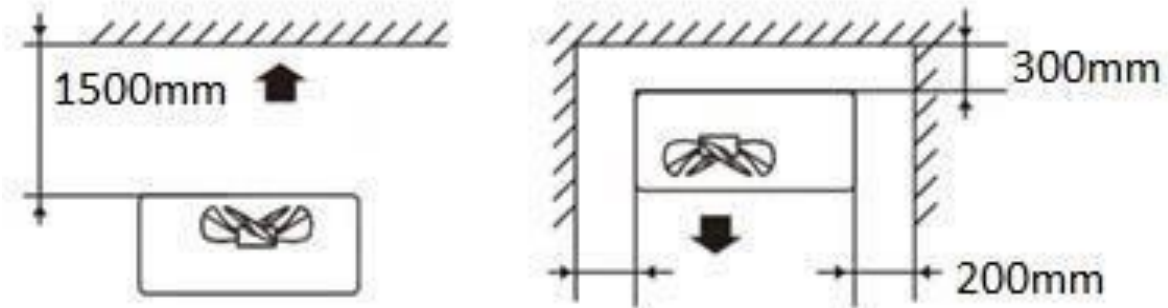

Installation of Drain Hose (optional)

The drain hose needs to be installed in the following manner to the location of the corresponding drainage outlet at the bottom of the cooling unit. In most cases the drain hose for condensed water is not needed.

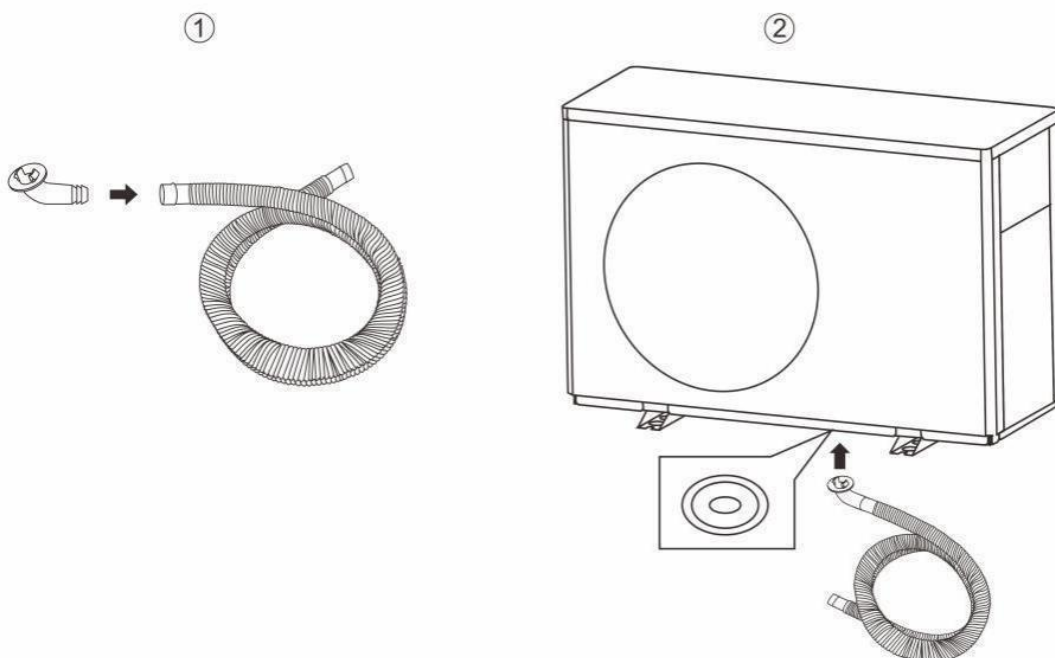

Attaching Water Hoses to unit

Use the hoses included in the delivery package. Threaded connectors are pre-attached in the hoses. Please make sure that the **sealing o-rings** are correctly in place before attaching the connector.

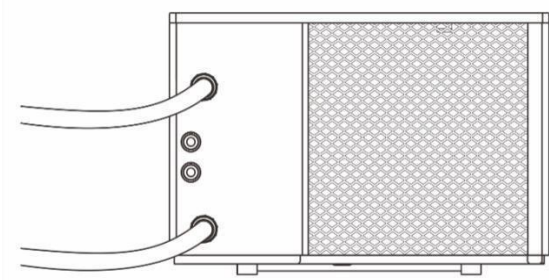

Layout of water circulation between the unit and pool

If the operating ambient temperature is below 0°C, please keep the unit running and at “Automatic” mode and do not use the “active mode” timer. Otherwise, the system will freeze.

The filter must be routinely cleaned to keep the water in the system clean and to avoid filter clogging. Replace the cartridge filter when needed, usually every 2-4 months depending on volume of use.

Hose installation:

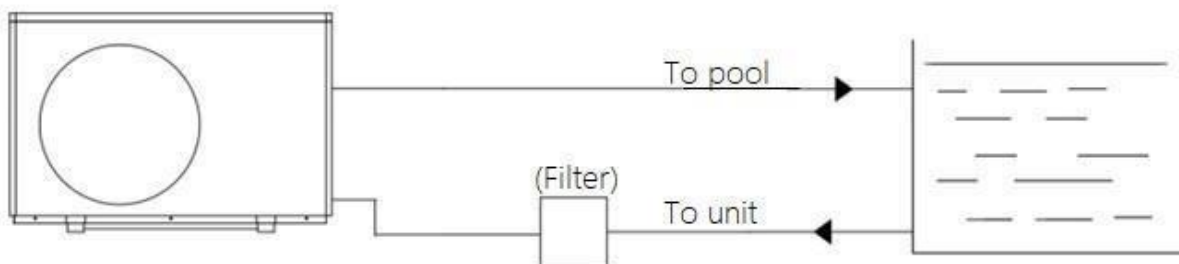

Hanki pool + CHU – implementation steps

1. Attach the step.

- Turn the step into place as shown in the picture.



2. Attaching the hoses to the pool (with Camlock connectors).

- Push the hose into the connector as shown in the picture.



3. Lock the connector as shown in the picture.

- Note: You can secure the Camlock connectors with the safety pins.



4. Attach the connectors (unit).

- Remember to put the **o-ring** inside the connector and turn clockwise until tight.



5. Attach the small filter

- CHU always comes with a filter, either with small metal grid filter or optionally with a cartridge filter. Should you have the small filter, install it to the lower connectors of both pool and the CHU, so that the arrow on top of the filter points towards CHU.

6. Attach the optional cartridge filter (instead of small filter).

- a. Use scissors to cut off the cable tie.
- b. Install the gasket on the valve and turn the valve clockwise to tighten.
- c. Valves with seals and hoses installed.

Attach the cartridge filter to the lower connectors of both pool and the CHU, so that the arrow on top of the filter points towards CHU.



a)



b)



c)

7. Ensure that your setup resembles this: the upper hose from the unit should connect to the upper hole in the pool, and the lower hose should connect to the lower hole in the pool.



Setup with small filter



Setup with cartridge filter

Kide Pool + CHU – implementation steps

1. Attach the air pump hose to the pool, as shown in the picture, and apply approximately 0.3-0.5 bar of pressure into the pool.



2. Attach the connectors: unit/pool.
Place the **o-ring** inside the connector and turn clockwise until tight.



3. Attach the small filter
CHU always comes with a filter. Attach the filter to the lower connectors of both pool and the CHU, so that the arrow on top of the filter points towards CHU.

4. Ensure that your setup resembles this.



Filling the Pool and letting air out of the unit

Fill the pool slightly below the upper nozzle.

Should you have the optional cartridge filter installed, then press air button on top of the filter until water is starting to run out of the orifice.

Turn on the unit.



If the air does not come out of the unit and no flow (error P01) appears after 1 minute, unplug the unit and restart it. When you see the water flowing, fill the pool to desired level





Operation

Controller Interface



Operation Instruction of Controller

Power and Screen Lock

To unlock, press any key to light up the screen and long press “” 5 seconds until you hear a “beep” sound. The lock icon “” disappears. Long press the “” key to turn the unit on or off. After 60 seconds without pressing any button, the controller will be locked automatically. When locked, the lock icon “” is displayed.

Modes (Cooling / Heating / Auto)

When the unit is on, short press “” key to select the operating modes. The circular selecting sequence is Cooling → Heating → Auto → Cooling... (continual loop)



NOTE: Auto mode → there is a delay in changing the cooling / heating direction.

The heating icon “” will display when heating mode is on.







The cooling icon “” will display when cooling mode is on.

When running in Auto mode, loop icon “” and cooling icon “” will display.

Temperature Setting









When the cooling unit is on, unlock the screen (see “Power and Screen Lock”). Press up “” or down “” to adjust the temperature. No actions for 3 seconds will exit the display showing the current water temperature.





Time Setting

1. Enter Time Setting: Long press the “” key for 5 seconds until the digit in both “hour” and “minute” parts flash.
2. Time Setting Method: On the time setting interface, short press “”. Then the hour digit in area will blink. Press “” or “” to adjust Hour. Press “” to switch to Minute part and repeat above actions. When setting is done, press “” to save the setting and to exit to main interface.





Power ON/OFF Timer Setting (“Active Mode”)

1. Users can set up two ON/OFF “active mode” timer periods. The set periods may not overlap.
2. Power ON/OFF Timer Setting Method

On main interface, short press “” to enter power on/off timer setting. When “1” is blinking, press “” to enter the power ON hour part setting of “active mode” period 1. When the hour part is blinking, press “” or “” to adjust the hour. Press “” to confirm and to enter the minute part. When power ON minute part is blinking, press “” or “” to adjust the minute. Press “” to confirm the power ON minute part and enter power OFF timer setting of period 1. Repeat above actions.

When setting is done, long press “” to confirm and save the current power ON/OFF timer setting. Press “” or “” to enter setting of “active mode” period 2 and repeat above actions. Valid timer group will be shown on the main interface with corresponding number. Short press “” to main menu.

Ozonator Setting

When the cooling unit is on, long press the on/off button  if the screen is locked. Long press the mode button  so that L0 appears on the screen. Use the down arrow key  to change the value to L11 and press mode (short). Use the arrow keys  and  to change the value to 0, 1 or 2 (see table below).

Press the mode button (short) and then the on/off button (short).

(The ozone generating timing starts when the unit is turned on)

Code	Parameter Name	Setting Range	Factory Default
L11	Ozonator control method	0: No ozone generating 1: Ozone generating 5 minutes every hour (55 minutes standby) - Private use 2: Ozone generating 10 minutes every hour (50 minutes standby) - Heavy / public use	1

Error messages on Display

When the fault occurs, the corresponding error code will appear. After the error is eliminated, the error code will disappear. To reset the error code, restart the unit.

Error Code List

Fault code	Description
E01	Gas exhaust temperature fault
E05	Coil temperature fault
E09	Gas suction temperature fault
E17	Inlet water temperature fault
E18	Outlet water temperature fault
E22	Ambient temperature fault
P01	Water flow switch fault
P02	High pressure protection
P06	Low pressure protection
P11	Gas exhaust temperature over high protection
P15	Inlet/outlet water excessive temperature protection
P16	Overcooling protection
P17	Standby anti-freeze protection
P25	Ambient temperature protection
P26	Outlet water over high temperature protection under heating mode
P27	Outside coil over high temperature protection under cooling mode

General maintenance and quality of water

Maintenance of the pool. Make sure the water stays clean and clear. Depending on the utilization frequency, occasional use of chlorine might be needed to disinfect the water (especially in heavy public use).

On daily basis: Check the water level.

On weekly basis: Clean the possibly stained water line and the filter. Flush the filter thoroughly under warm running water or shower (do not use pressure washers as it may damage the filter material). The filter cartridge should be replaced always, if after cleaning the filter, the water circulation is not at normal level. Depending on the rate of usage, filter should be replaced every 2 to 6 months. Check the water pH level which should be maintained on normative level (7,2 – 7,6). When needed, you can finetune the pH level by using pH+ or pH- chemicals. Should the pool be in heavy daily use, it is recommended to add half teaspoon of chlorine (natriumdiklorisocyanurat, dihydrat) to the water to reach the 0,3 – 1,2 ppm free chlorine level. If the number of the users exceeds 10 users/day, or if the water temperature exceed 15°C, it is recommended to add chlorine (natriumdiklorisocyanurat, dihydrat) frequently to the water in order to maintain 0,3 – 1,2 ppm free chlorine level.

Maintenance tips

1. Check the power and cable connections regularly. If any problems found, contact your local dealer.
2. Clean/vacuum the cooling unit regularly (usually 2-4 months) to ensure free ventilation.
3. When the cooling unit is not in use, plug it off.
4. If the cooling unit is not in use for a longer period, let all water out from the cooling unit.
5. Troubleshooting
 1. If the control panel is blank and the cooling unit is not running, check the power supply and/or if the residual-current device has activated. If the power supply is ok but the residual-current device has turned off the power, push the reset button to re-start the unit. Should the problem remain, unplug the device and contact the retailer or manufacturer.
 2. If there is no water circulation after switching the unit on, switch off the unit for a while and on again. This may happen due to air locks in the pipes. Repeat, if needed, until the water starts circulating.
 3. If the water is not circulating properly, check the water level and condition of the filter (cartridge, if used). Add more water if needed. Clean the filter or replace cartridge, if needed. Should problem remain, please contact the retailer or manufacturer.

Should the cartridge filter's housing be tight and difficult to open, use the opening tool that is included in the filter package.



Warranty

Model: Avantopool Hanki Pool

3 YEARS:

- Hanki pool and step (model APH001)

These materials have a 3-year warranty, which applies to fractures and breaking without external influence or other misuse of the device (see below limitations)

Model: Avantopool Kide

1 YEAR:

- Kide pool (inflatable) and cover (model APK001)

Model: Cooling/Heating Unit APCU032

Private use 2 YEARS / Commercial use 1 YEAR Warranty:

- Mechanical and electrical parts: pump, heat exchanger, condenser, compressor, heater
- Control panel and control system
- Hoses, connectors
- Lid (optional)
- Filter housing

APCU032 and parts/components mentioned above have a limited 2-year warranty (private use) / limited 1-year warranty (commercial use) which applies to breaking without misuse of the device (see limitations below).

WARRANTY DOES NOT COVER:

- Damage or defect caused by misuse of the device, wrong or inadequate electrical current or connection, negligence, inappropriate on-site operating conditions, repairs by non-Avantopool designated personnel, tampering, alterations or accidents in later transportations.
- Flood or rainwater, insect infestation, dust / sand dust or unreasonable outdoor exposure.
- Damage caused due to the product not being reasonably installed, operated, maintained or used in accordance with Avantopool's instructions and specifications (User Manual).
- Damage caused by unauthorized alterations, accident, misuse, abuse, use of an incorrect voltage, power surges, thunderstorm activity, tampering and unauthorized repairs, or exposure to abnormally corrosive conditions.
- Damage caused by using chemicals or minerals in the pool water.
- Damage caused by water or other liquids entering the electrical or electronics of the device through negligence.
- Damage caused by severely overheating the product due to negligence, such as covering the cooling unit's ventilations grills with towels, clothing, or other objects, or operating the cooling unit too close to a wall or in a room/place with insufficient ventilation.

Following instructions stated in the User Manual is imperative. Follow the maintenance routines is utmost important. Damage cause by neglecting the maintenance routines may void the warranty.

ORIGINAL OWNER & COUNTRY OF SALE

Warranty is available only to the original purchaser / owner purchased from Avantopool directly or from an approved Avantopool reselling partner. This warranty is not transferable except with the written consent of Avantopool. The warranty applies only in the country where the product was purchased or delivered to the original owner.

PROOF

Proof of the purchase date, cooling unit serial number and that the claimant is the original purchaser may be required. Additionally, Avantopool reserves the right to request the return to Avantopool of any component replaced under warranty, or alternatively, proof that the faulty component was destroyed.

RIGHT TO REPAIR OR REPLACE THE PRODUCT

Avantopool reserves the right to replace the product or relevant part of the product with the same or equivalent product or part rather than repair it.

SEPERATE WARRANTY ON REPLACED COMPONENTS

Where defective parts are replaced with new parts, the new part will carry a separate warranty from the date of replacement, however this does not restart the original standard warranty.

RESPONSE TIME & PLACE OF REPAIR WORK

Avantopool undertakes to approve and provide repair work promptly, however we will not accept responsibility for any costs whatsoever regarding any repair work or transport costs that were not specifically approved by Avantopool prior to any such work or transport taking place. At its discretion, Avantopool may either repair the product at the premises of the owner of the product, or if the repair is beyond the scope of a local repair agent, Avantopool may request that the product be shipped back to its factory for a more thorough and comprehensive examination and repair. Where Avantopool determines that the repair needs to be carried out at its factory, Avantopool will be responsible for the cost of land transport so long as that transport is arranged by or approved by Avantopool. Avantopool will not be responsible for freight services arranged without its consent. This limited warranty gives you specific legal rights in addition to remedies provided by local laws and regulations, which may vary from country to country.