

avant°pool

Avantopool Kide with Cooling & Heating Unit

Installation and User Manual



Please read this manual carefully
before installation, operation or maintenance.

Table of Content

Warning	3
COOLING & HEATING UNIT INSTALLATION.....	4
Installation Distance for the Unit.....	4
Installation of Drain Hose (optional)	4
Attaching Water Hoses to unit	5
Layout of water circulation between the unit and pool (filtering is optional).....	5
OPERATION OF THE UNIT	6
Controller Interface.....	6
Operation Instruction of Controller	6
Power and Screen Lock.....	6
Modes (Cooling / Heating / Auto)	6
Temperature Setting.....	7
Error messages on Display	7
Error Code List	7
Time Setting.....	8
Power ON/OFF Timer Setting ("Sleep Mode").....	8
Filling the Pool and letting air out of the unit.....	9
Kide Pool – implementation steps.....	10
MAINTENANCE.....	11
General maintenance and quality of water.....	11
Maintenance tips	11
WARRANTY	12

Warning

- a. For repairs, please contact service. The repair process must be done in strict accordance with this manual. All maintenance operations by non-professional personnel are prohibited and will void warranty.
- b. Misoperation may result in injury to personnel or damage to equipment.
- c. Please make sure that the pool is filled up and air is removed from the unit piping before starting the unit. It is forbidden to start this equipment before a certain the water level has been established. Otherwise, there is a risk of damage to this equipment.
- d. In winter or when the ambient temperature drops below 0°C, be sure to empty the water from the cooling unit if it is not in use. Otherwise, the unit will be damaged by freezing, in which case your warranty will be voided.
- e. When there is a need to cut the power for repair, wait for 1 minute after power is off before touching the circuit board, to avoid capacitor discharge resulting in electric shock.
- f. **The cooling unit must be stored and transported vertically in its original packaging.** If not, wait at least 24 hours before being powering the unit.
- g. The correct power supply, voltage, and frequency must be confirmed before installation.
- h. Improper installation may result in fire, electric shock, equipment falling, or water leakage.
- i. Make sure no water penetrates the electrical components.
- j. **The unit may be damaged by severely overheating the product due to negligence, such as covering the cooling unit's ventilations grills with towels, clothing, or other objects, or operating the cooling unit too close to a wall or in a room/place with insufficient ventilation.**
- k. Do not use any method to speed up the defrosting process or to clean the frosted parts, as this will cause risk of damage to the unit. The unit will do it automatically.
- l. Do not use salt or other minerals in the water.
- m. This equipment is not intended for use by children. Children must be supervised by an adult while using it to ensure their safety.
- n. Persons with a history of heart disease, low or high blood pressure, circulatory system problems, diabetes, or any condition requiring medical treatment should consult a physician or a doctor before using the pool.
- o. Persons using medication should consult a physician or a doctor before using the pool since some medication may induce drowsiness while other medication may affect heart rate, blood pressure and circulation.
- p. Pregnant women should consult a physician or a doctor before using the pool.

COOLING & HEATING UNIT INSTALLATION

Installation Distance for the Unit

The cooling unit should be installed in a well-ventilated area. It should be installed in the place greater than the following distances:

- Min. distance between unit front and wall = 1500mm (150 cm)
- Min. distance between unit back and wall = 300mm (30 cm)
- Min. distance between unit sides and wall = 200mm (20 cm)

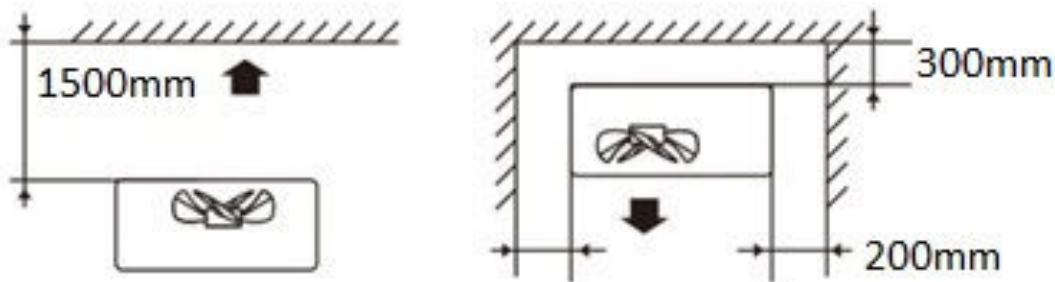

Installation of Drain Hose (optional)

The drain hose needs to be installed in the following manner to the location of the corresponding drainage outlet at the bottom of the cooling unit. In most cases the drain hose for condensed water is not needed.

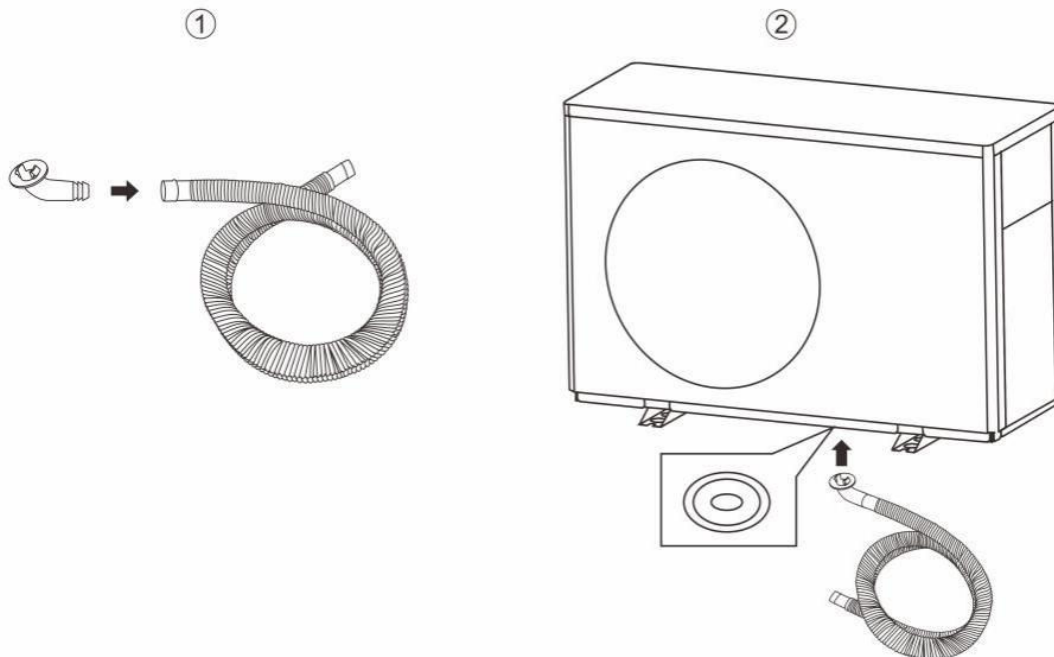

Attaching Water Hoses to unit

Use the hoses included in the delivery package. Threaded connectors are pre-attached in the hoses. Please make the sealing o-rings are correctly in place before attaching the connector.

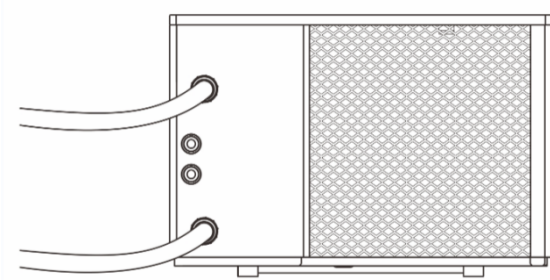

Layout of water circulation between the unit and pool (filtering is optional)

If the operating ambient temperature is below 0°C, please keep the unit running and at "Automatic" mode and do not use the "sleep mode" timer. Otherwise the system will freeze.

If filtering is used, the filter must be routinely cleansed to keep the water in the system clean and to avoid filter clogging. Replace the filter when needed, usually every 2-4 months depending on volume of use.

Hose installation:

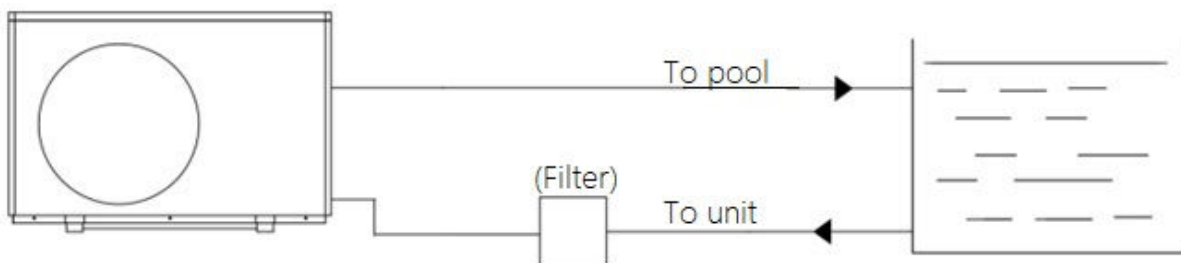



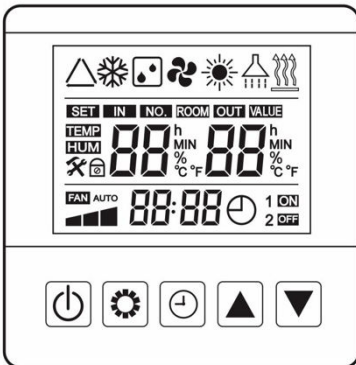

OPERATION OF THE UNIT

Controller Interface



Operation Instruction of Controller

Power and Screen Lock

To unlock, press any key to light up the screen and long press “” 5 seconds until you hear a “beep” sound. The lock icon “” disappears. Long press the “” key to turn the unit on or off. After 60 seconds without pressing any button, the controller will be locked automatically. When locked, the lock icon “” is displayed.



Modes (Cooling / Heating / Auto)

When the unit is on, short press “” key to select the operating modes. The circular selecting sequence is Cooling → Heating → Auto → Cooling... (continual loop)

NOTE: Auto mode → there is a delay in changing the cooling / heating direction.

The heating icon “” will display when heating mode is on.

The cooling icon “” will display when cooling mode is on.

When running in Auto mode, loop icon “” and cooling icon “” will display.

Temperature Setting

When the cooling unit is on, unlock the screen (see "Power and Screen Lock"). Press up

"▲" or down "▼" to adjust the temperature. **No actions for 3 seconds will exit to**

display showing set target temperature and the current water temperature.

Error messages on Display

When the fault occurs, the corresponding error code will appear. After the error is eliminated, the error code will disappear. To reset the error code, restart the unit.





Error Code List

Fault code	Description
E01	Gas exhaust temperature fault
E05	Coil temperature fault
E09	Gas suction temperature fault
E17	Inlet water temperature fault
E18	Outlet water temperature fault

E22	Ambient temperature fault
P01	Water flow switch fault
P02	High pressure protection
P06	Low pressure protection
P11	Gas exhaust temperature over high protection
P15	Inlet/outlet water excessive temperature protection
P16	Overcooling protection
P17	Standby anti-freeze protection
P25	Ambient temperature protection
P26	Outlet water over high temperature protection under heating mode
P27	Outside coil over high temperature protection under cooling mode

Time Setting









(1) Enter Time Setting: Long press the " " key for 5 seconds until the digit in both "hour" and "minute" parts flash.





(2) Time Setting Method: On the time setting interface, short press " ". Then the hour digit in area will blink. Press " " or " " to adjust Hour. Press " " to switch to Minute part and repeat above actions. When setting is done, press " " to save the setting and exit to main interface.

Power ON/OFF Timer Setting ("Sleep Mode")

(1) Users can set up two ON/OFF "sleep mode" timer periods. The set periods may not overlap.

(2) Power ON/OFF Timer Setting Method

On main interface, short long press " " to enter power on/off timer setting. When "1" is blinking, press " " to enter the power ON hour part setting of "sleep mode" period 1. When the hour part is blinking, press " " or " " to adjust the hour. Press " " to confirm and enter the minute part. When power ON minute part is blinking, press " " or " " to adjust the minute. Press " " to confirm the power ON minute part and enter power OFF timer setting of period 1. Repeat above actions.

When setting is done, press " " to confirm and save the current power ON/OFF timer setting. Press " " or " " to enter setting of "sleep mode" period 2 and repeat above actions. Valid timer group will be shown on the main interface with corresponding number. Short press " " to main menu.

Filling the Pool and letting air out of the unit

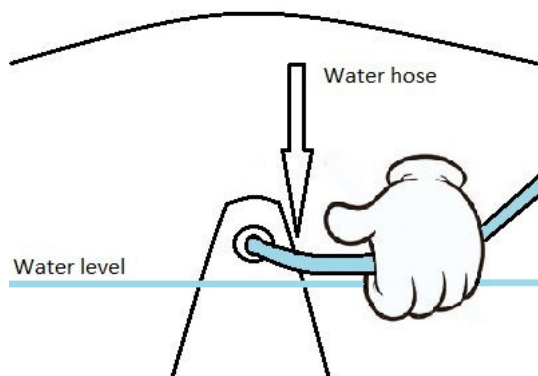

Fill the pool slightly below the upper nozzle and use same water hose to run water from the upper nozzle to get air out of the unit. Then turn on the unit.

If the air does not come out of the unit and no flow (error P01) appears after unit starts, stop the unit, and run water from the upper nozzle again, keep the hose tightly in the upper nozzle.

Restart the unit and fill the pool to desired level.

This same procedure also helps to flush dirt out from the unit piping, should error code "P01" occur during use.

Kide Pool – implementation steps

1. Attach the pump hose to the pool, as shown in the picture, and apply approximately 0.3-0.5 bar of pressure into the pool.



2. Attach the connectors: unit/pool
 - a. Place the o-ring inside the connector and turn clockwise until tight.



3. Ensure that your setup resembles this: the upper hose from the unit should connect to the upper hole in the pool, and the lower hose should connect to the lower hole in the pool.

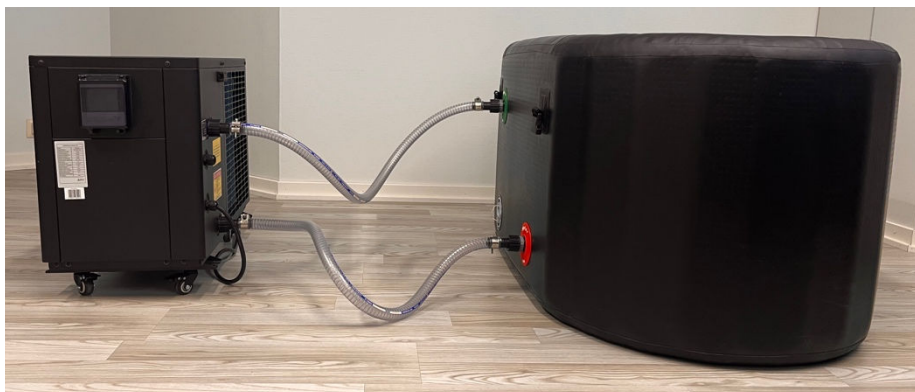

4. Fill the pool with water.

MAINTENANCE

General maintenance and quality of water

Maintenance of pool. Make sure the water stays clean and clear. Depending on the utilization frequency, occasional use of chlorine might be needed to disinfect the water (especially in heavy public use)

On daily basis: Check the water level.

On weekly basis: Clean the possibly stained water line and the filter. Flush the filter cartridge thoroughly under warm running water or shower (do not use pressure washers as it may damage the filter material). The filter cartridge should be replaced always, if after cleaning the filter, the water circulation is not at normal level. Depending on the rate of usage, filter should be replaced every 2 to 6 months. Check the water pH level which should be maintained on normative level (7,2 – 7,6). When needed you can finetune the pH level by using pH+ or pH- chemicals. Should the pool be in heavy daily use it is recommended to add half teaspoon of chlorine (natriumdiklorisocyanurat, dihydrat) to the water to reach the 0,3 – 1,2 ppm free chlorine level. If the number of the users exceeds 10 users/day, or if the water temperature exceed 15°C, it is recommended to add chlorine (natriumdiklorisocyanurat, dihydrat) frequently to the water in order to maintain 0,3 – 1,2 ppm free chlorine level.

Maintenance tips

1. Check the power and cable connections regularly. If any problems found, contact your local dealer.
2. Clean the cooling unit regularly (usually 3-4 months) to ensure free ventilation.
3. When the cooling unit is not in use, plug it off.
4. If the cooling unit is not in use for a longer period, let all water out from the cooling unit.
5. Troubleshooting
 1. If the control panel is blanc and the cooling unit is not running, check the power supply and/or if the residual-current device has activated. If the power supply is ok but the residual-current device has turned off the power, push the reset button to re-start the unit. Should the problem remain, unplug the device and contact the retailer or manufacturer.
 2. If there is no water circulation after switching the unit on, switch off the unit for a while and on again. This may happen due to air locks in the pipes. Repeat if needed until the water starts circulating.
 3. If the water is not circulating properly, check the water level and condition of the filter cartridge (if used). Add more water if needed. Clean the filter cartridge or replace it if needed. Should problem remain, please contact the retailer or manufacturer.

WARRANTY

Model: Avantopool Hanki

3 YEARS:

- Pool (model APH002)
- Hoses, connectors
- Lid (optional)
- Filter housing (optional)

These materials have a 3-year warranty, which applies to fractures and breaking without external influence or other misuse of the device (see below limitations)

2 YEARS:

- Cooling unit (aggregate) as a whole (model APCU032)
 - Mechanical and electrical parts: pump, heat exchanger, condenser, compressor, heater
 - Control panel and control system

1 YEARS:

In commercial use the warranty is 1 year.

- Cooling unit (aggregate) as a whole (model APCU032)
 - Mechanical and electrical parts: pump, heat exchanger, condenser, compressor, heater
 - Control panel and control system

These parts and combinations (aggregate) have a limited 1-2-year warranty which applies to breaking without misuse of the device (see limitations below).

WARRANTY DOES NOT COVER:

- Damage or defect caused by misuse of the device, wrong or inadequate electrical current or connection, negligence, inappropriate on-site operating conditions, repairs by non-Avantopool designated personnel, tampering, alterations or accidents in later transportations.
- Flood or rainwater, insect infestation or unreasonable outdoor exposure
- Damage caused due to the product not being reasonably installed, operated, maintained or used in accordance with Avantopool's instructions and specifications (User Manual)
- Damage caused by unauthorized alterations, accident, misuse, abuse, use of an incorrect voltage, power surges, thunderstorm activity, tampering and unauthorized repairs, or exposure to abnormally corrosive conditions

- Damage caused by the use of chemicals or minerals in the pool water.
- Damage caused by water or other liquids entering the electrical or electronics of the device through negligence.
- Damage caused by severely overheating the product due to negligence, such as covering the cooling unit's ventilations grills with towels, clothing, or other objects, or operating the cooling unit too close to a wall or in a room/place with insufficient ventilation.

Following instructions stated in the User Manual is imperative. Follow the maintenance routines is utmost important. Damage cause by neglecting the maintenance routines may void the warranty. ORIGINAL OWNER & COUNTRY OF SALE Warranty is available only to the original purchaser / owner purchased from Avantopool directly or from an approved Avantopool reselling partner. This warranty is not transferable except with the written consent of Avantopool. The warranty applies only in the country where the Kinos pool was purchased or delivered to the original owner.

PROOF

Proof of the purchase date, cooling unit serial number and that the claimant is the original purchaser may be required. Additionally, Avantopool reserves the right to request the return to Avantopool of any component replaced under warranty, or alternatively, proof that the faulty component was actually disposed of or destroyed.

RIGHT TO REPAIR OR REPLACE THE PRODUCT

Avantopool reserves the right to replace the product or relevant part of the product with the same or equivalent product or part rather than repair it.

SEPERATE WARRANTY ON REPLACED COMPONENTS

Where defective parts are replaced with new parts, the new part will carry a separate warranty from the date of replacement, however this does not restart the original standard warranty.

RESPONSE TIME & PLACE OF REPAIR WORK

Avantopool undertakes to approve and provide repair work promptly, however we will not accept responsibility for any costs whatsoever in regard to any repair work or transport costs that were not specifically approved by Avantopool prior to any such work or transport taking place. At its discretion, Avantopool may either repair the product at the premises of the owner of the product, or if the repair is beyond the scope of a local repair agent, Avantopool may request that the product be shipped back to it's factory for a more thorough and comprehensive examination and repair. Where Avantopool determines that the repair needs to be carried out at it's factory, Avantopool will be responsible for the cost of land transport so long as that transport is arranged by or approved by Avantopool. Avantopool will not be responsible for freight services arranged without its consent.

This limited warranty gives you specific legal rights in addition to remedies provided by local laws and regulations, which may vary from country to country.